



“ Electric Heating, Sensing and Control Technology ”

Welcome to **National Plastic Heater, Sensor and Control Inc's** frequently asked heater questions page. These, address Mica, Ceramic Band and Cartridge Heaters. Other helpful measuring and installation tips, tools, engineering links and formulas are included. If your question is not addressed here you may send a question to our engineers for review.

Question:

What is the best way to install a band heater?

Answer:

These suggestions are for conductive heaters only. Ceramics, or “knuckle bands” have different considerations when installing.

After removing the defective band heater from the barrel or nozzle, inspect the area to be covered by the new heater and make sure it is clean and free from obstructions. Assure that there are no hydraulic fluids or materials that will become trapped between the heater and the barrel. If need be, use a wire brush and solvent to prepare the barrel, then wipe it down and make sure it is totally dry and free of debris before installing your new heater.

REMEMBER: If there are any holes, nicks or air spaces between the heater and the area to be heated, the life of the heater will be significantly shortened. These imperfections should be addressed before installing the heater or when ordering a new heater, assure that there will be no heater coverage over the area in question. The better and more complete the contact between the heater and the area being heated, the better the heat transfer. The better the heat transfer, the longer the heater will live under normal operating conditions.



“ Electric Heating, Sensing and Control Technology ”

www.nphheaters.com
1877-674-9744

If using post terminals, make sure you are using high temperature connectors. Typical industrial connectors will fail rapidly and nickel ring terminals should be used. If the environment is exposed to material dust to the point of heaters failing due to carbonization of particulate dust, try ceramic post terminal covers and fiberglass tape (with silicone or non-organic adhesive) to insulate exposed lead wire and ring terminal from the atmosphere. Be sparing with the tape and make sure you give as much space as you can between the connector and the heater. When installing, make sure the strap(s) or clamping mechanism are tight.

After you are satisfied that the heater is installed and wired correctly, check to make sure your temperature sensors are seated firmly and power it up. Give a quick check to assure it is drawing the right current and bring it up to 75% of operating temperature, and cut the power to it. Make sure there is no power going to the heater and retighten all appropriate clamping mechanisms before the heater contracts.

You are now ready to power your heater back up and the job is done. For maximum heater life, check the tightness of the clamping mechanisms at least once a week. Remember, most heaters that fail prematurely in the field, fail due to contamination or improper installation. Both these reasons are avoidable and with a little extra care and common sense, you can extend the life of your heaters and save your machines from that dreaded unscheduled downtime.

Question:

What's the best way to test a heater before installing it?

Answer:

A disconnected heater can be expected to work properly when installed if its resistance measures within ten percent of an easily calculated optimum level.



“ Electric Heating, Sensing and Control Technology ”

www.npheaters.com

1877-674-9744

To calculate the heater's resistance value, first solve for R using the formula $R=V \times V / (W \times 1.065)$, where R equals ohms, V equals voltage and W equals wattage.

Volts and watts should be stamped on the heater. The 1.065 factor accounts for the fact that the resistance of the nichrome element wire increases resistance by about 6.5 percent from room temperature to hot temperature.

Next, test the heater using an ohmmeter. Make sure at least one of the two lead wires is not connected to anything. Measure the resistance from one lead wire to the other lead wire.

If the resistance you measure is within 10 percent of the calculated value of R, the heater should be good, though it is possible to measure some resistance if part of the heater is good and part is bad.

Question:

How can I test a heater without stopping production?

Answer:

During operation, a heater that's working properly will draw current in amperes within ten percent of an easily calculated optimum level.

To check a heater on a running machine, you first need to figure the optimum level of current your heater should draw. Use the formula $I=W/E$, where I is the current in amperes, W is the wattage and E is the voltage.

You should find the watts and volts stamped on the heater. To find I, the current in amperes, use a clamp-on ammeter. For the meter to read correctly, you must measure the current in only one of the lead wires going to the heater. You must also make the measurement while the controller is calling for heat, because the temperature controller turns the heater off some of the time.

If the current you measure is within ten percent of the optimum performance value of I that you calculated, the heater is most likely good.

A bad heater may still draw current. For example, the inside of the heater may be made up of two parallel heaters. If one of the parallel heaters is bad, the current will be half the calculated amount. Depending on how the inside of the heater is constructed, it is possible to measure several different current values, indicating that part of the heater is bad and part is still working.



“ Electric Heating Sensing and Control Technology ”

www.npheaters.com

1-877-674-9744

Question:

Ceramic Knuckle Bands or Mica Band Heaters?

Answer:

It seems that at least once a week, we have a customer changing from mica heaters to ceramic heaters or from ceramics to mica. If you're thinking of a change or if you're simply curious, we'd like to offer a little information here to help you make an informed decision. The two greatest things about using ceramic heaters are the potential energy savings and the fact that less heat is released to the atmosphere than with mica heaters. While we wouldn't recommend touching the sheath of a ceramic heater, we can say that the consequences of an accidental encounter are less severe than an experience with a mica band. From our field studies, we have determined that our ceramic band heaters typically use 10% less energy than a mica band heater when manufactured with extra heat saver insulation.

National Plastic Heater's ceramic heaters have two standard insulation options as shown below. There are many other options available as to clamping options, terminations, leads and lead protection. Please see our Ceramic Heater pages <http://www.nphheaters.com/products/ceramic.htm> for listings and sketches of available options.

The 'business end' of our ceramic heater is the construction of high quality ceramic "knuckles" which support coiled nickel-chromium element wire. This assembly is sheathed in stainless steel. These heaters are extremely flexible allowing for easy installation, can operate at higher temperatures than mica heaters and are longer lived as well! This can mean quicker start up times translating to extra production time.

Another item of consideration is the fact that extremely tight fits and irregularities in the mounting surface are not as critical with ceramic versus mica due to the fact that much of the heat is transferred via radiant energy.

Downsides to ceramic heaters would be that they are thicker than mica heaters, and widths are only available in ½" increments. When selecting a knuckle band, you need to consider that they do not lend themselves to repeated reinstallations. While price is higher than mica heaters, the savings in energy and longer lived heaters more than makes up for any price difference.



“ Electric Heating, Sensing and Control Technology ”

www.nphheaters.com

1-877-674-9744

Mica band heaters are great low cost heaters that are easily customized and quickly manufactured. They can last for years or months depending upon many different variables.

Positives for mica band heaters in addition to the low cost would have to include their versatility, low prices and ability to be manufactured in less time than ceramic heaters. When installed properly, they are an efficient and durable answer to process heating in an industrial environment.

Whichever route you take in your industrial process heating needs, you can depend on the **National Plastic Heater** team to do our best to provide you with the best solution available today.

Question:

I don't have a part number! How do I order?

Answer:

It's really pretty simple, after locating a configuration from the bottom of this page, determine the diameter of the part you want to install the heater on.

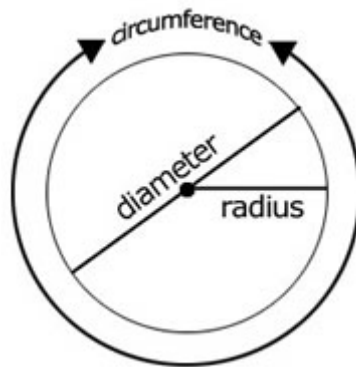

Hopefully, you can get this information from a drawing, but if not, you can refer to the above graphic and easily make your own measurement (We only need one of the dimensions from above). Next, determine the width of the heater and the length of the lead wire if appropriate.

After that, specify the wattage and the available voltage and you are ready to go! If there are holes or notches in your band heater see below for more information on how to measure your band heaters.



“ Electric Heating, Sensing and Control Technology “

www.nphheaters.com

Measuring Mica Band Heaters

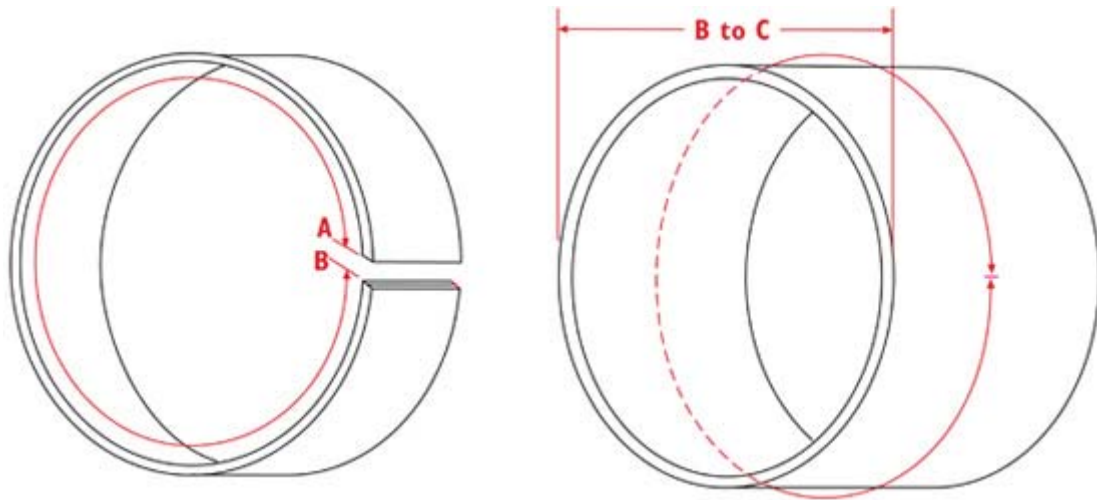

Heater Circumference Measurement

When measuring the circumference of a Band Heater the measurement should be made on the inside surface from Point A to Point B whenever possible. Also be sure to inform your customer service person of the gap size (space between Point A and Point B).

If the heater cannot be measured then the barrel circumference should be measured from Point A around to Point A again to determine barrel circumference or barrel can be measured from Point B to Point C above to determine Barrel O.D.

Also be sure to inform your customer service person of the gap size that is required.

Locating Holes by Part Feature and with Degrees or Clock Time

Hole Location

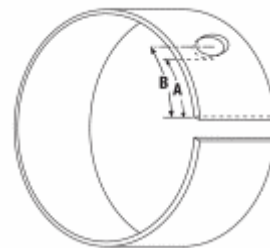

3/16".

The standard gap width on a one piece heater is 5/16".

For heaters that are available for four hour shipment the maximum gap width is 1" for a one or two piece heater.

centerline of hole.

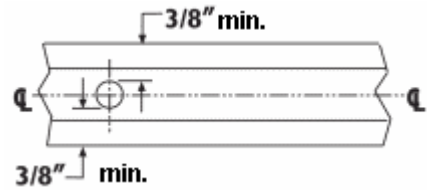

When a hole is on the centerline of the width of a heater the maximum hole size can be determined by subtracting 3/4" from the heater width.

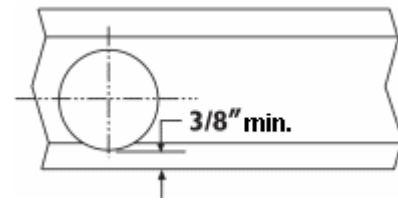

When a hole is offset to one side of a heater there must be a minimum of 3/8" clearance from edge of hole to edge of heater on one side of the hole

Degrees

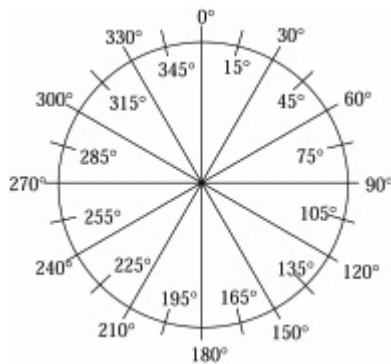

Clock Time

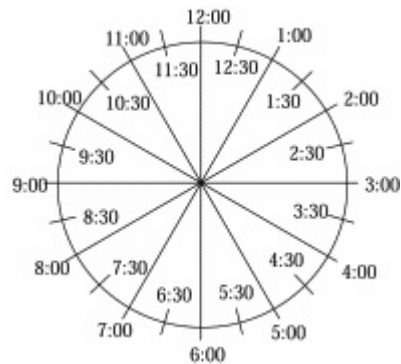

Holes should be located in degrees or clock time if possible, this will allow for the correct placement of holes. *Note: Every minute on the clock is 6°.*

Question:

How can I get longer life out of my cartridge heaters?

Answer:

- **Avoid Contamination.** Examples: When using a release agents, such as **NPH's** anti- seize, to ease heater removal from its hole, be sure to wait until agent is bone dry before inserting the heater into the hole. If the heater is inserted before the agent is dry, some of the liquid will usually be pushed towards the lead end and then will soak into the heater through the lead insulation or through the lava or ceramic plug at that end. When that happens, the heater can be expected to fail as soon as the power is applied. (Choosing the lead option of Teflon wire insulation and a Teflon plug can reduce the likelihood of water entering the heater, but this does not provide a fully hermetic seal, and the lead end of the heater must be restricted to 400 degrees F).
- Moisture, oil or other liquids on the lead wires can be wicked into the heater and cause early failure.
- Oil or other organic material on the lead end cap of the heater will carbonize at elevated temperature, causing a short from the leads to the sheath.

Avoiding Over-Temperature

- A loose fit of the cartridge heater in its hole will reduce the heater's lifetime because the heat generated is not transferred efficiently to the object or material being heated, causing the heater to run at a higher temperature to transfer its energy. The higher the operating temperature, the shorter the lifetime. A rule-of-thumb for the fit is to make the hole diameter no more than .005 inches greater than the diameter of the heater.
- Choose the lowest wattage heater that will maintain the desired operating temperature of part being heated and still provide a short enough start-up time that can be tolerated. Choosing a higher wattage and letting the temperature controller turn the heater off the amount of time that brings the heated part to the desired temperature results in higher operating temperature of the heater during its on-time and shortens its life.
- If used as an immersion heater, the type of fluid and its velocity passing over the heater are important factors. Ask for assistance from a **NPH** applications engineer.



“ Electric Heating, Sensing and Control Technology ”

www.nphheaters.com

1-877-674-9744

Excessive Cycling

- The way that **National Plastic Heater** evaluates the lifetime of their own cartridge heaters and those from competitors is to cycle the units from 150 degrees F to 1,400 degrees F and count the cycles to failure. Cycling reduces lifetime because the surface of the element wire oxidizes rapidly at higher temperatures; if the higher temperature is maintained, the oxide coating actually protects the wire from further oxidation.

But if the wire temperature is reduced substantially, the oxide coating breaks off due to contraction and exposes fresh metal to more oxidation. With continuous cycling, the wire diameter is eventually reduced, and the resistance of the element is increased to the point that it becomes too hot. At that point, the element wire either melts and breaks open the circuit, or it causes the insulation over the wire to break down, causing a short to the sheath.

Question:

Are the polarities of type J thermocouple wires color coded?

Answer:

Yes, ANSI/MC96.1 Red is negative and white is positive (Japanese JIS C 1610-1981 is the opposite).

And thanks to your question, we have now updated our website to include a link of specifications and color coding of the most common thermocouple types (as well as a few less common).

The chart may be found here:

http://www.nphheaters.com/products/thermocouples/thermocouples_int_codes.html

Question:

What is watt density and how is it related to heater life?

Answer:

Watt density is a measure of the rate of heat being transferred through the surface of the heater. That is, if you were to draw a 1"x1" square on the surface of the heater, how much heat would need to pass through that 1 square inch area. This is called watt density and it is measured as watts/square inch. Other things being equal, the higher the watt density, the higher the temperature inside the heater.



“ Electric Heating, Sensing and Control Technology ”

www.nphheaters.com

1-877-674-9744

As the temperature inside the heater increases, the materials inside the heater are operating closer to their breaking point resulting in shorter heater life.

Generally, for mica band heaters, for satisfactory heater life, the watt density should be less than 50 watts/square inch for heater diameters less than 3 inches, less than 40 watts / square inch for diameters between 3 and 6 inches and less than 35 watts / square inch for heaters with diameters between 6 and 10 inches.

For cartridge heaters, the watt density should be less than 200 watts / square inch. For ceramic knuckle band heaters, the watt density should be less than 35 watts / square inch. Also, higher operating temperatures require lower watt density for equivalent temperatures inside the heater and equivalent heater life.

Helpful Tools, Calculators, Technical Letters and Engineering Links

Ohms Law Calculator Below:

http://www.nphheaters.com/tool_box/ohms_law_calculator.htm

Temperature Conversion Calculator Below:

http://www.nphheaters.com/tool_box/temperature_conversion_calculator.htm

Technical Letters Below:

<http://www.nphheaters.com/technical/letters.htm>

Technical Resource Center Below:

http://www.nphheaters.com/quote/industrial_process_heaters/formulas.htm#quick_estimates



“ Electric Heating, Sensing and Control Technology ”

www.nphheaters.com

1-877-674-9744

Please see our Products link page below, for all your Electric Heating, Temperature Sensing and Temperature Control requirements.

<http://www.nphheaters.com/products/products.htm>



“ Electric Heating, Sensing and Control Technology ”

National Plastic Heater, Sensor and Control Inc.

www.nphheaters.com

sales@nphheaters.com

Toll Free: 1-877-674-9744

Tel: 905-859-8225

Fax: 905-859-4691

Terms and Conditions posted at the link below apply:

<http://www.nphheaters.com/terms.htm>